

18 GUTTER DETAIL

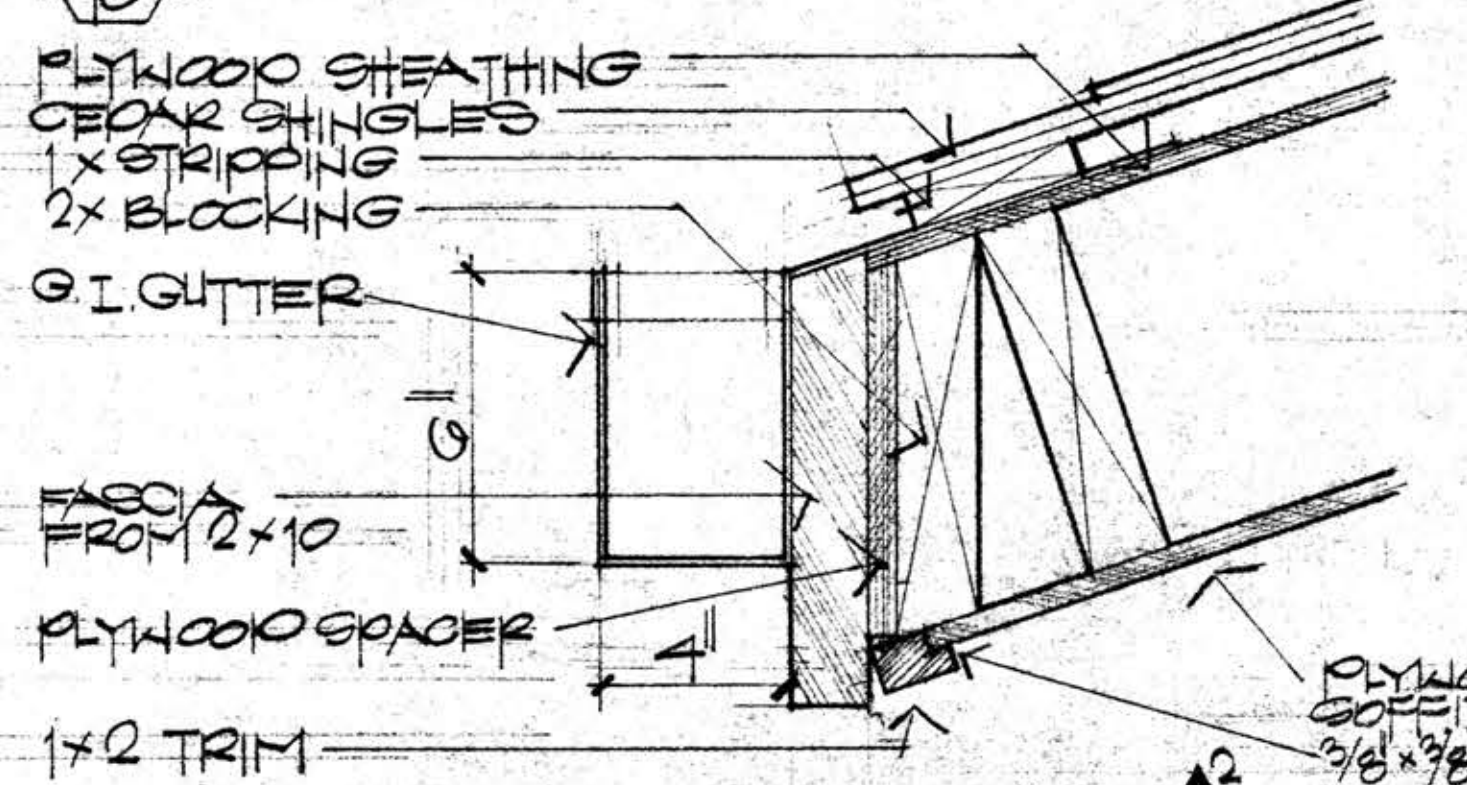

19 GUTTER DETAIL

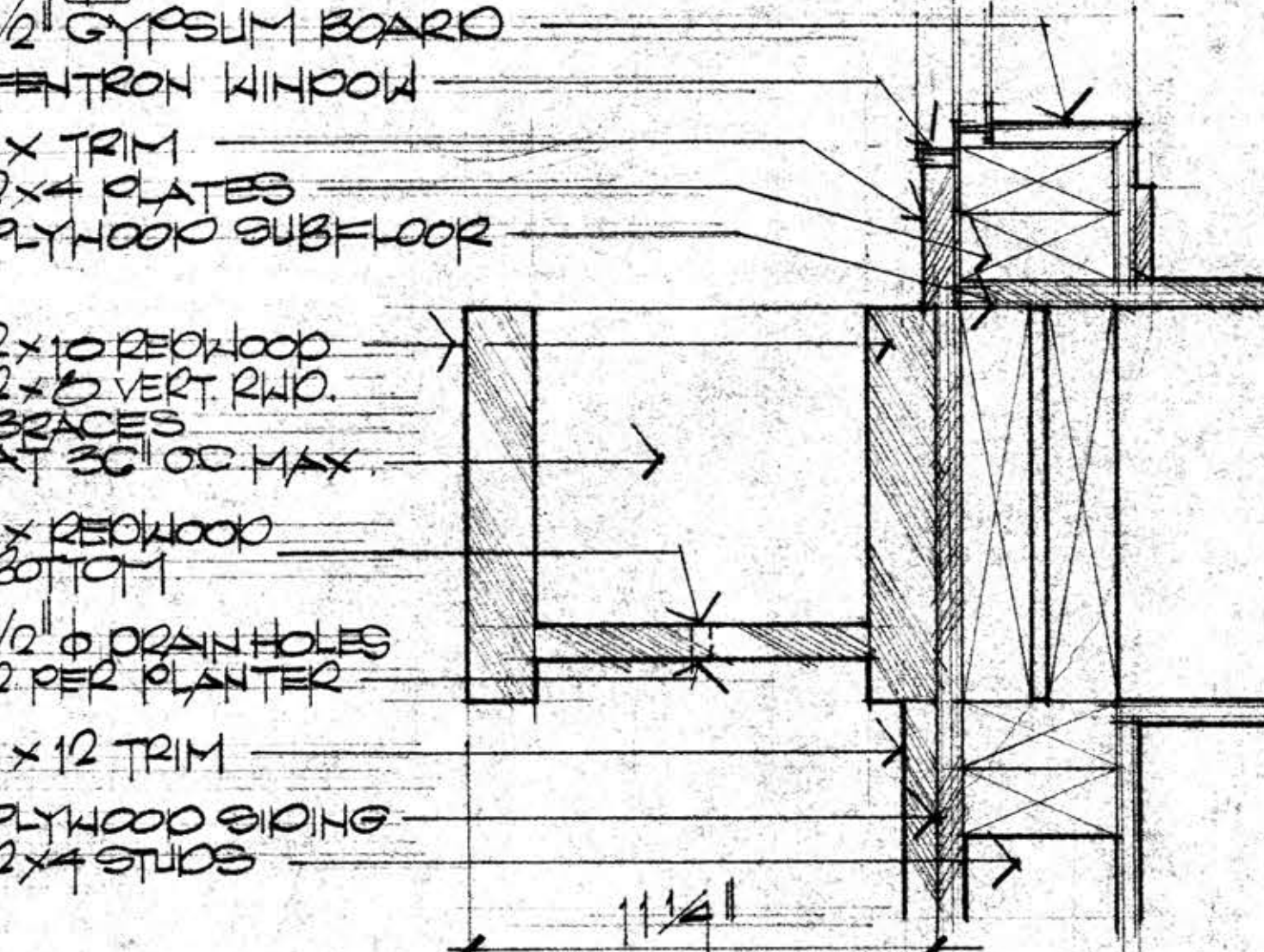

20 PLANTER BOX DETAIL

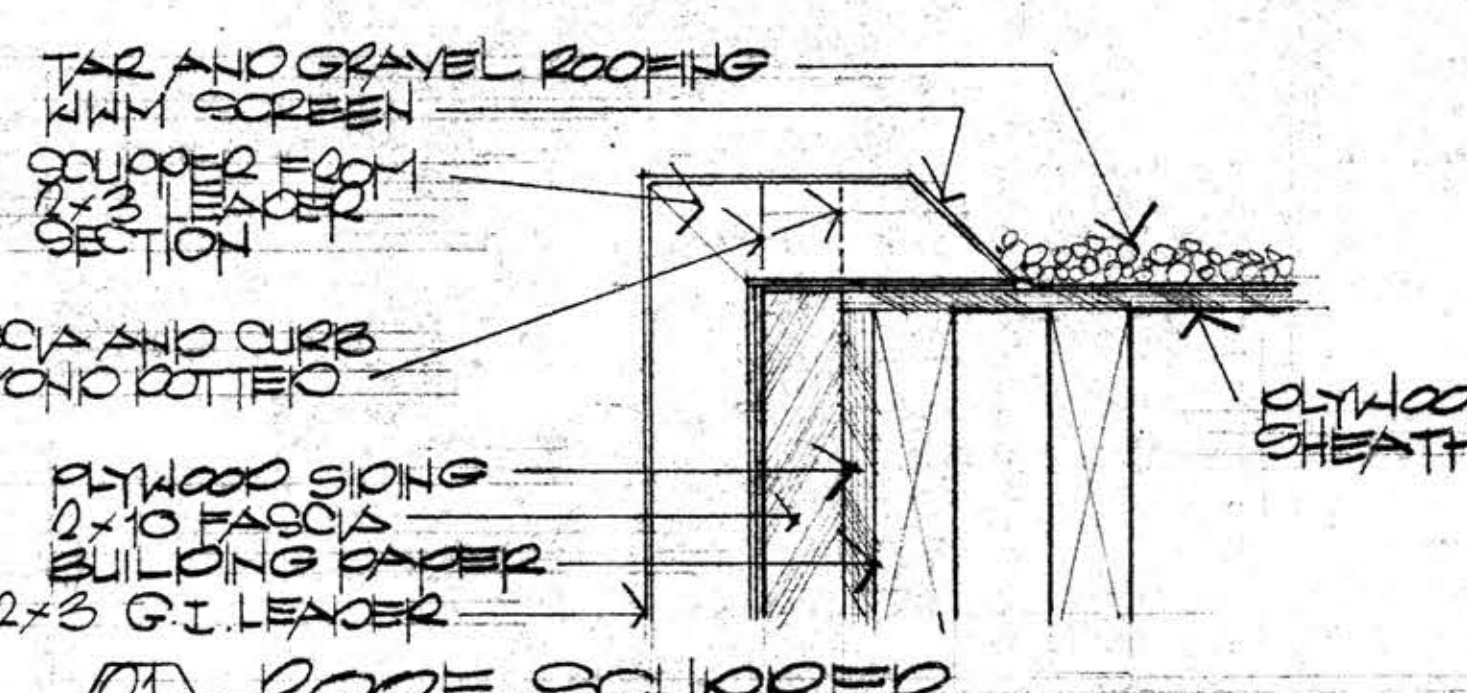

21 ROOF SCUPPER

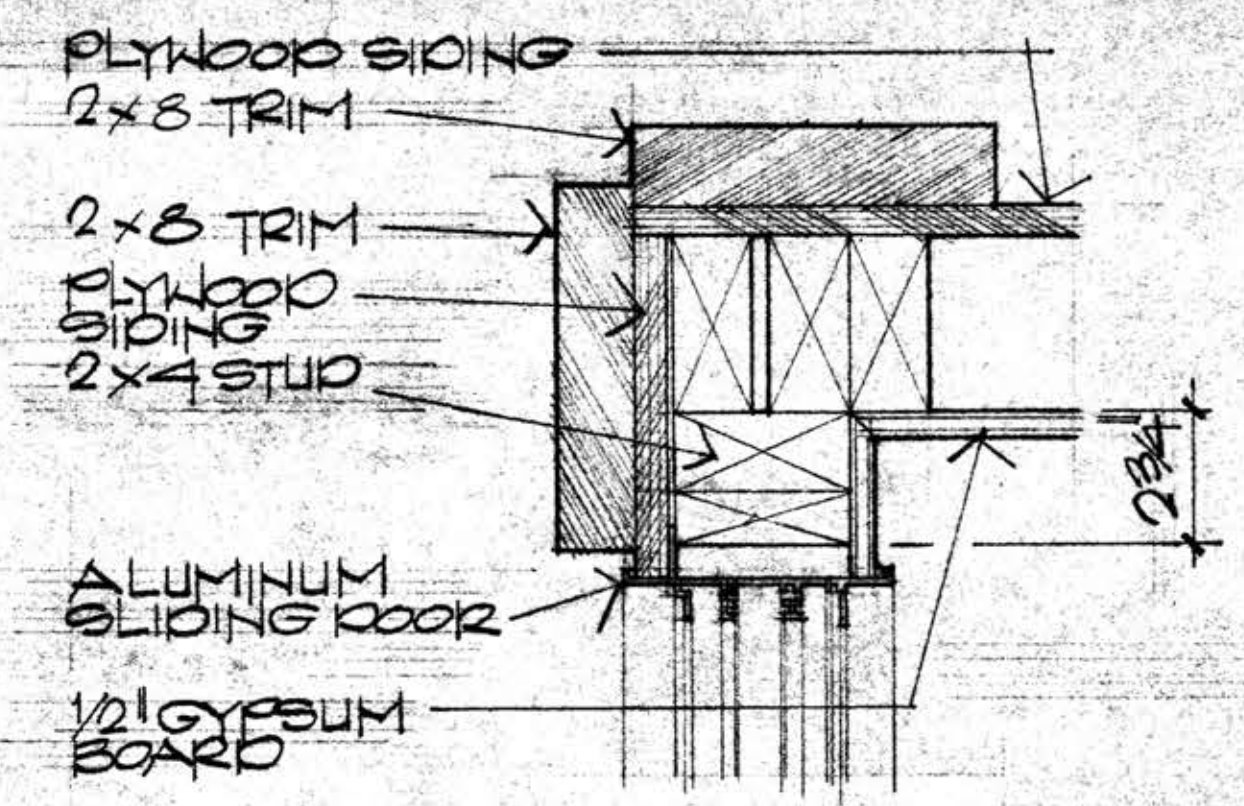

14 JAMB

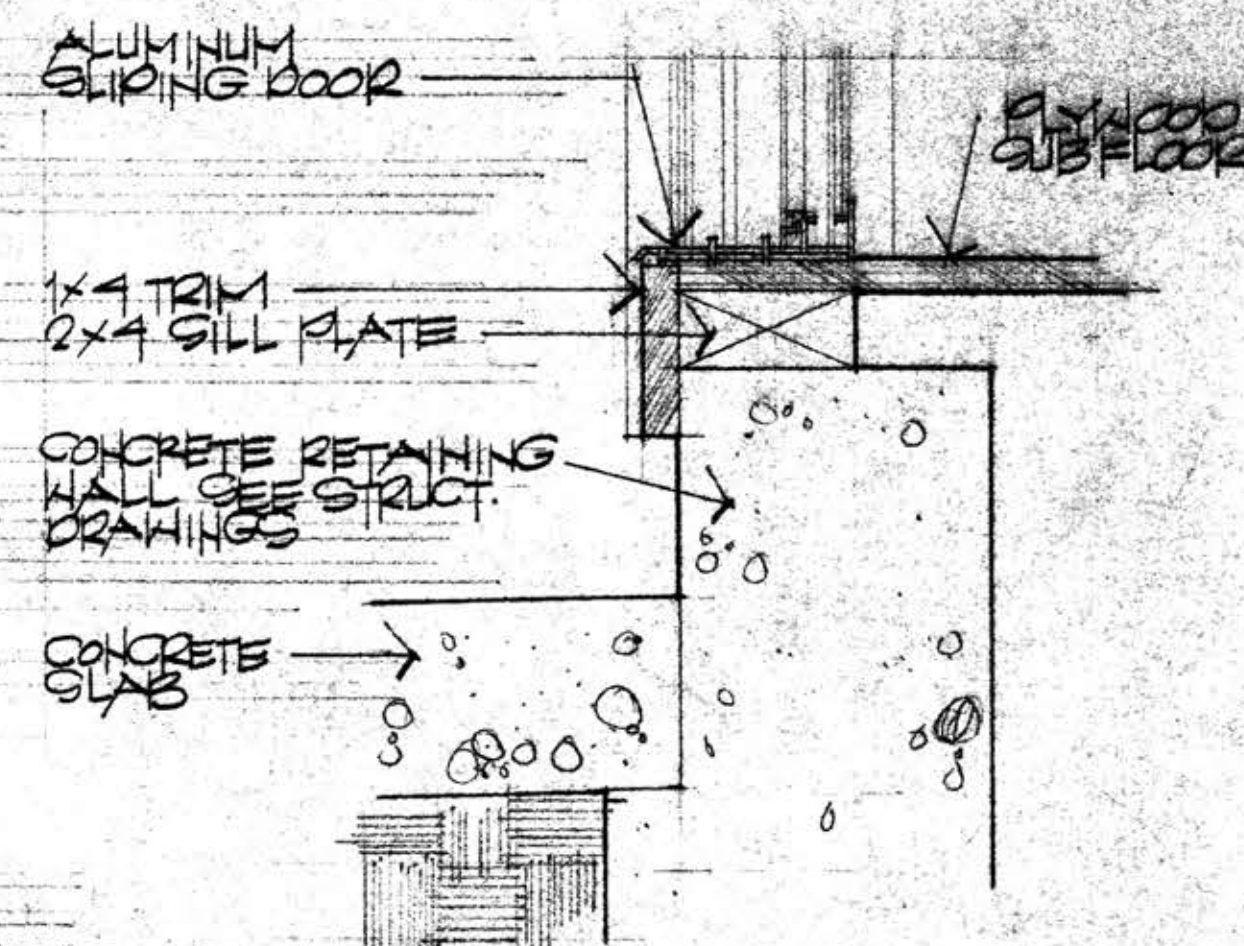

15 SILL-SLIDING DOOR

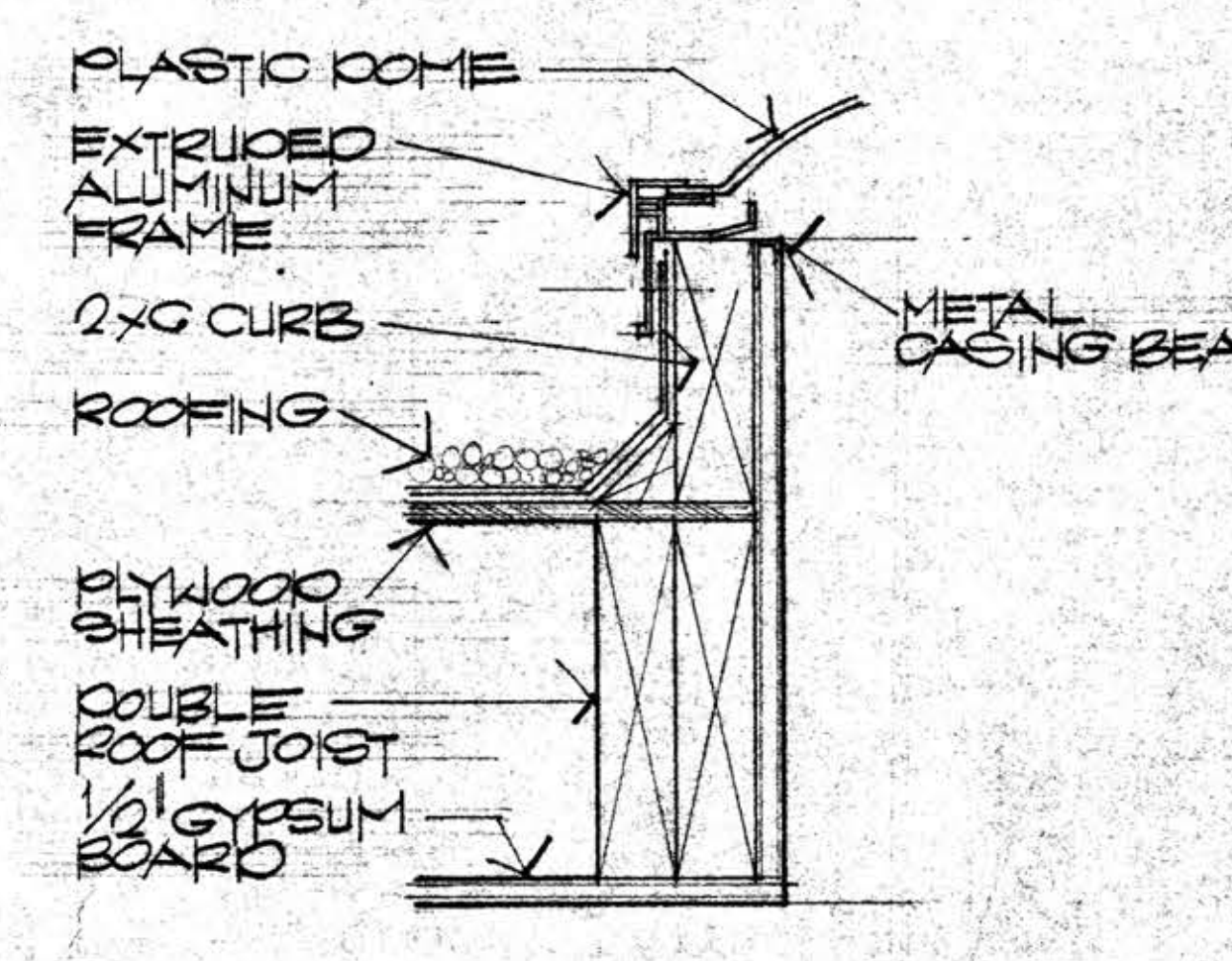

16 SKYLIGHT DETAIL

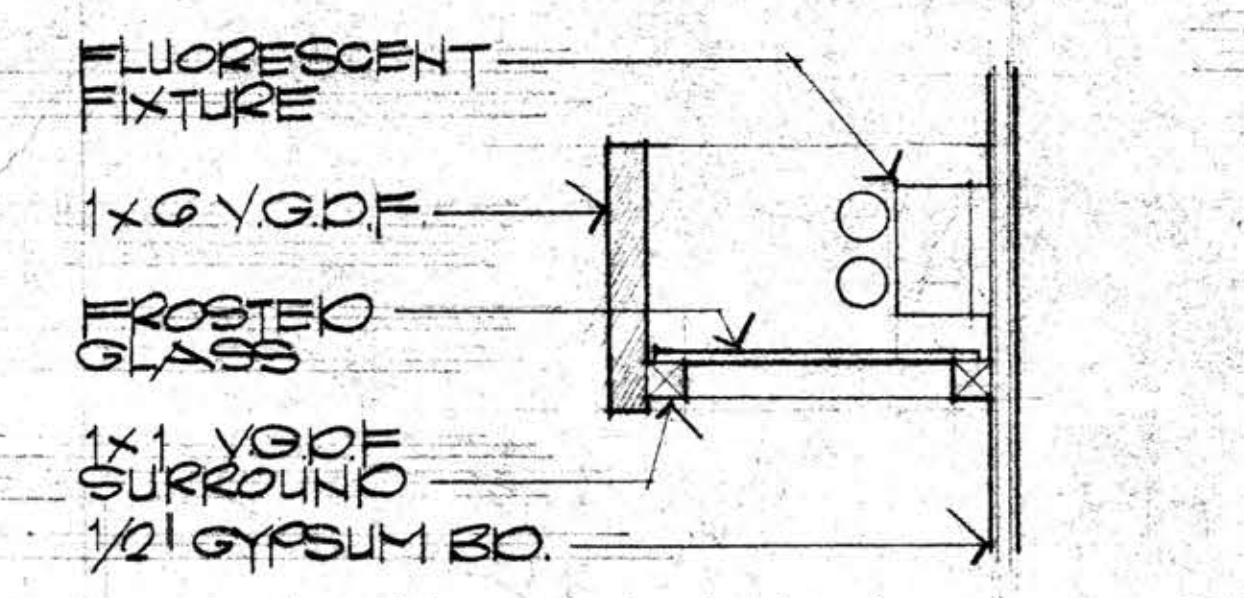

17 LIGHT VALANCE

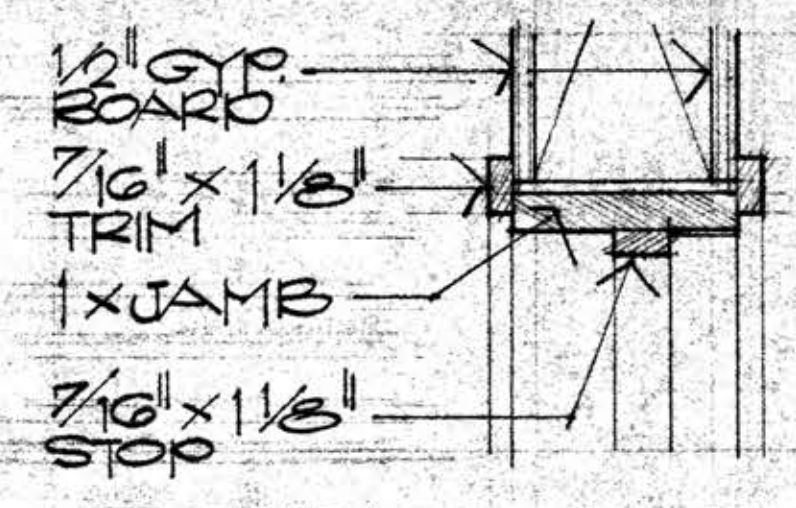

9 HEAD-INTERIOR
10 JAMB SIMILAR

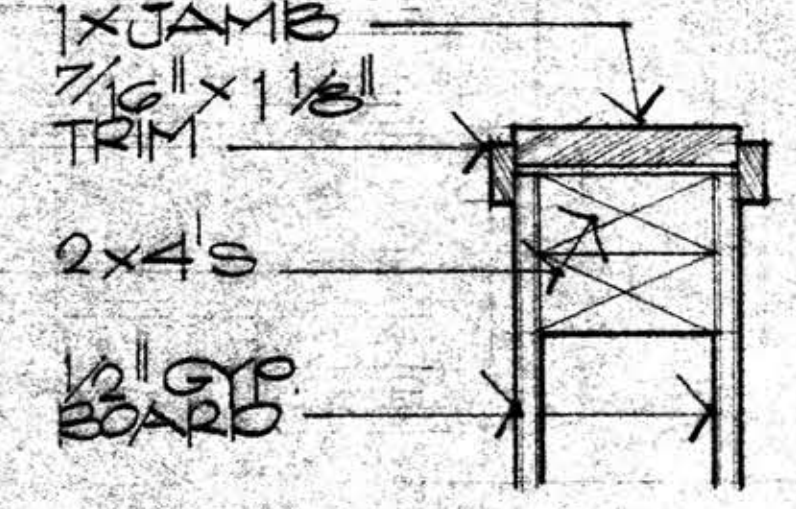

10 STAIR RAIL

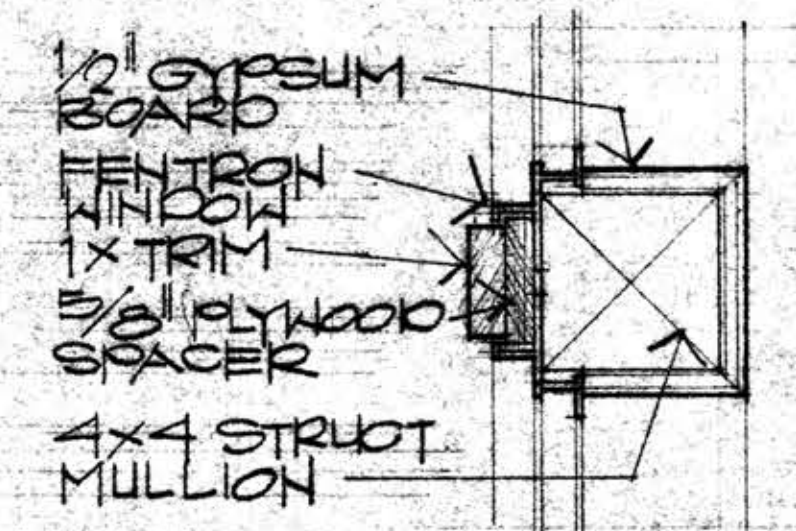

11 MULLION

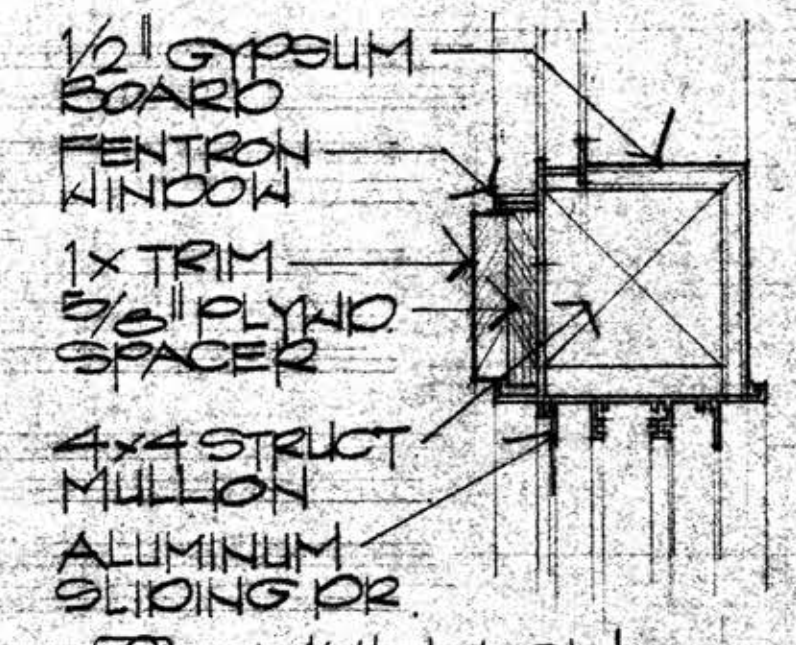

12 MULLION

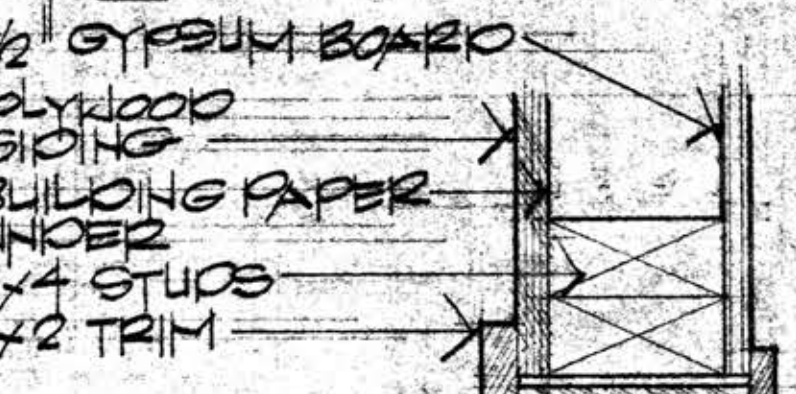

13 JAMB

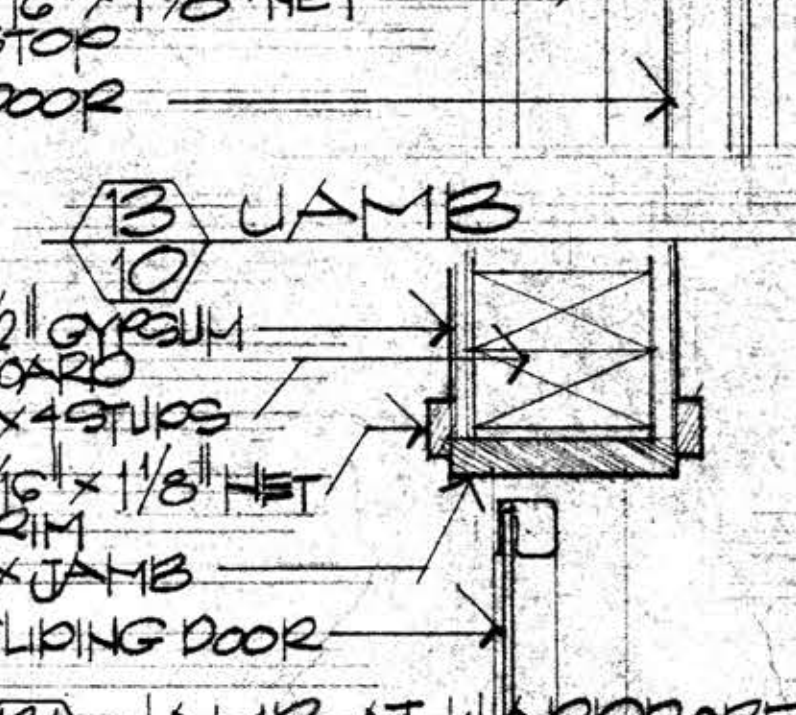

13A JAMB AT WARDROBE

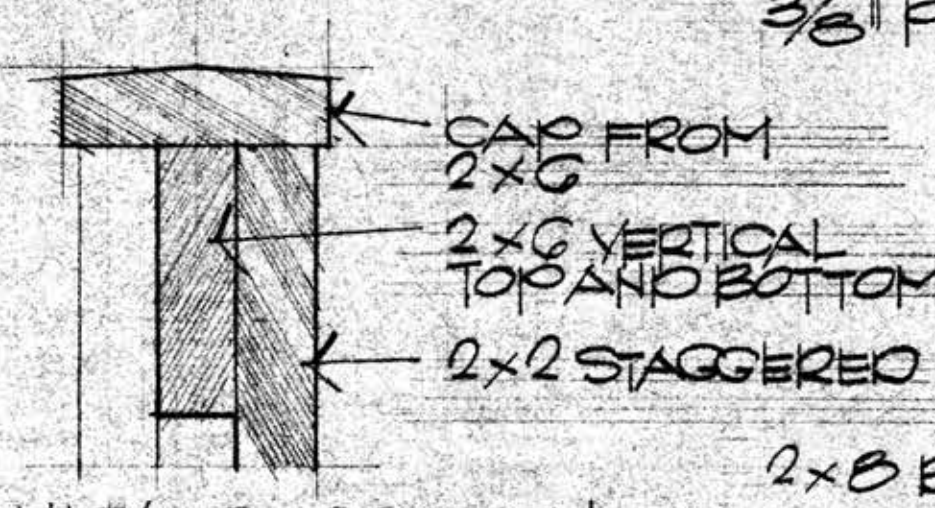

4 HEAD-SCREEN

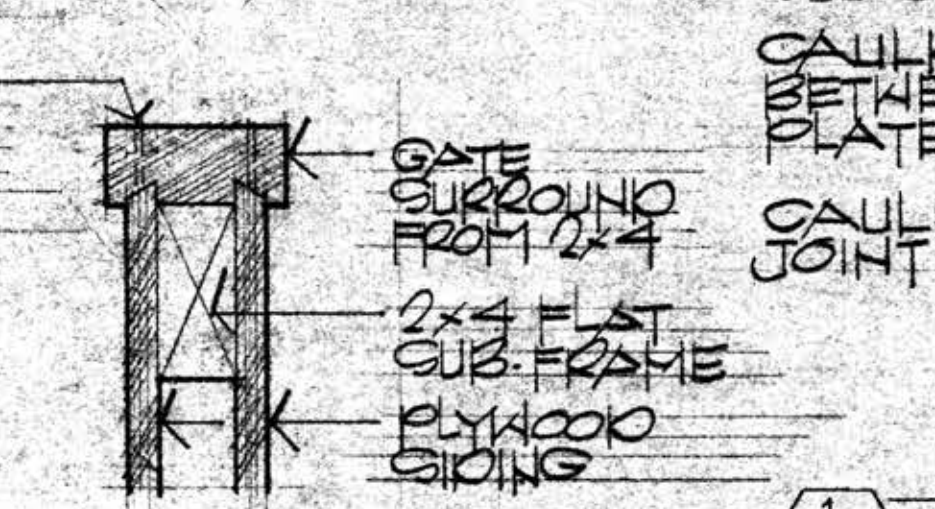

5 ENTRY GATE

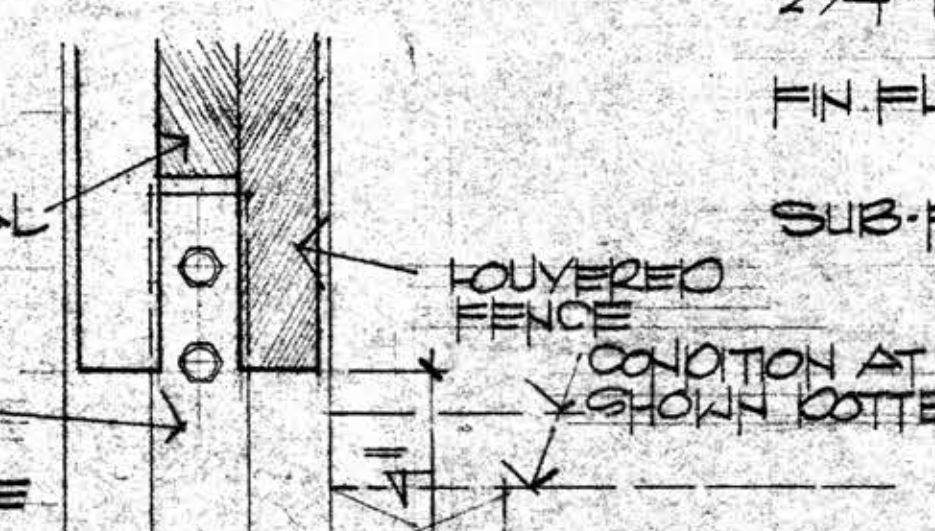

6 SILL-SCREEN

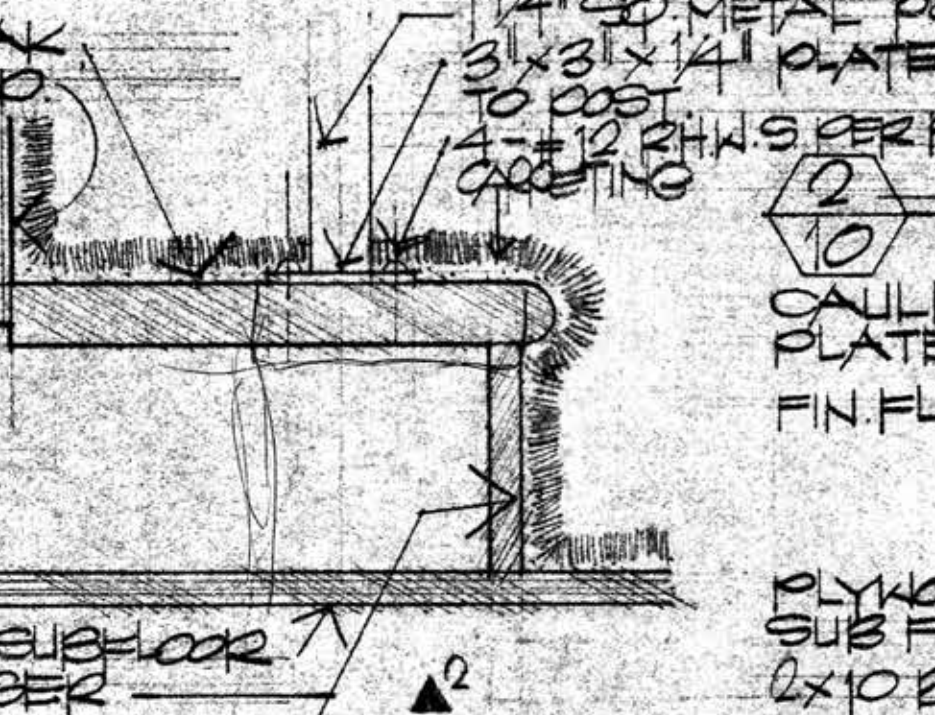

7 STAIR DETAIL

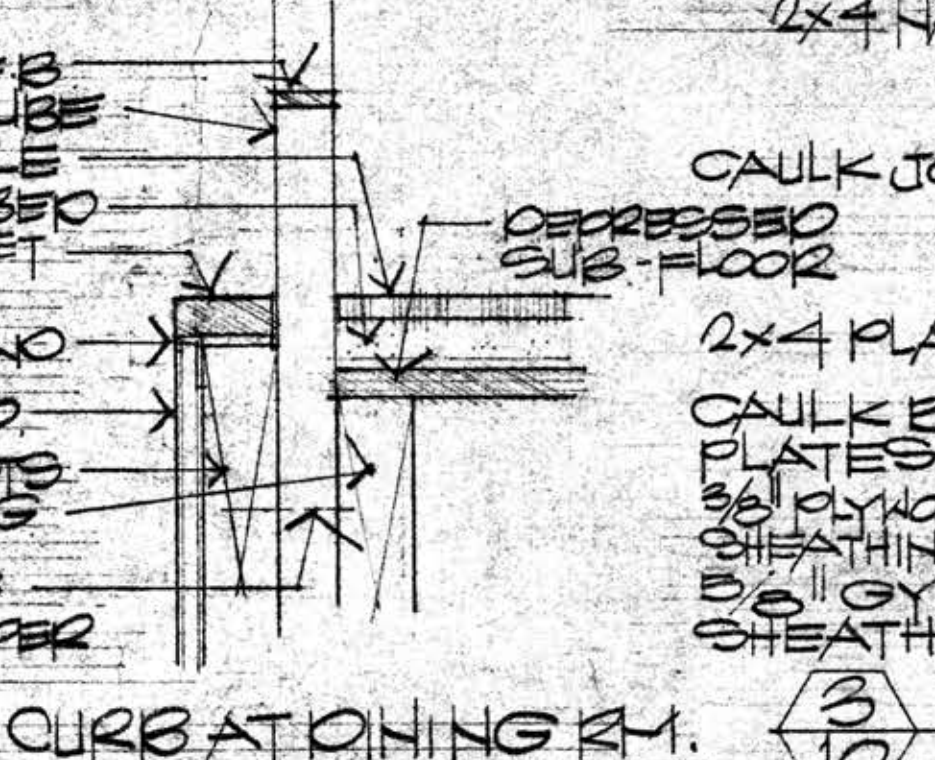

8 CURB AT OPENING RM.

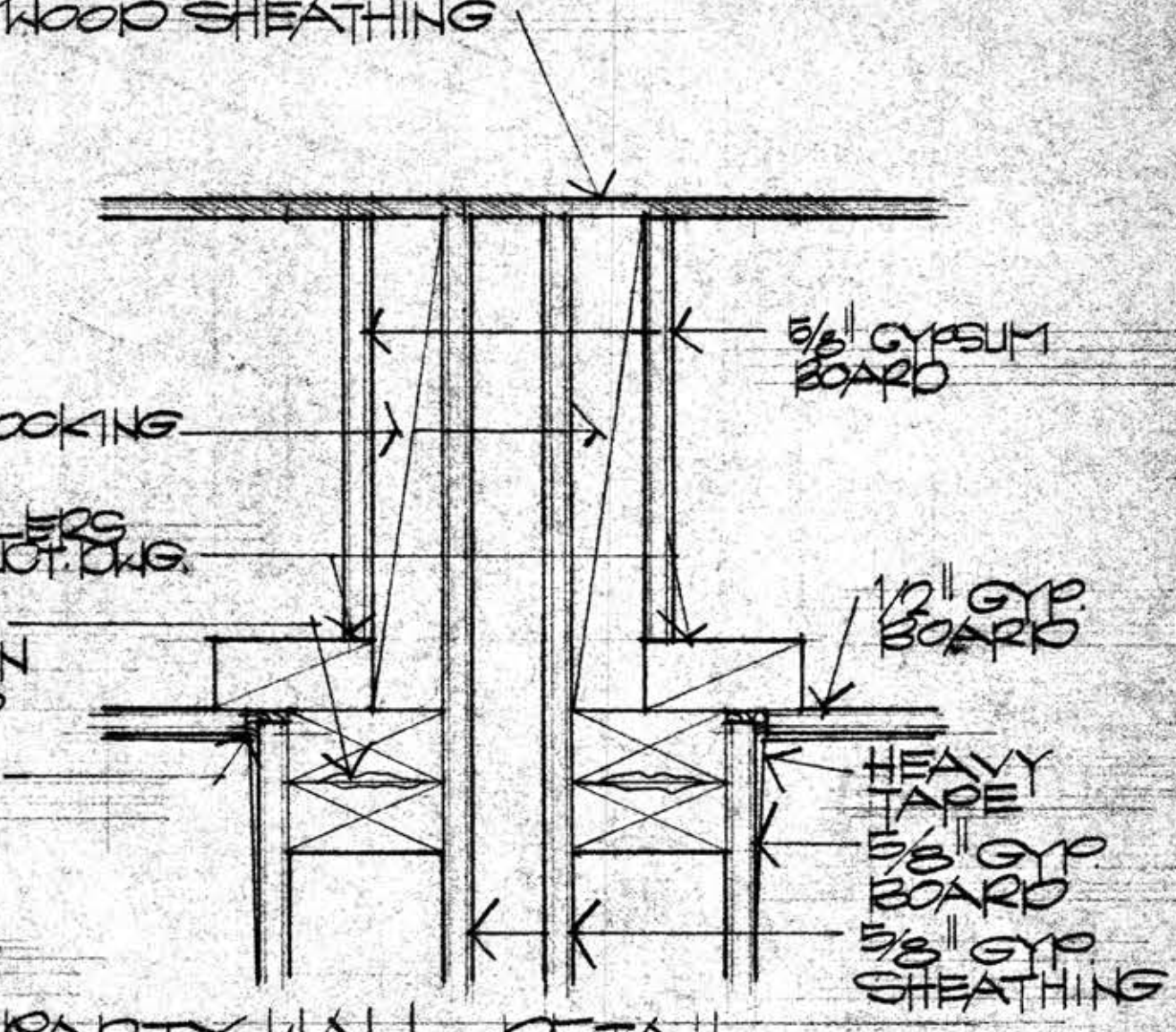

1 PARTY WALL DETAIL

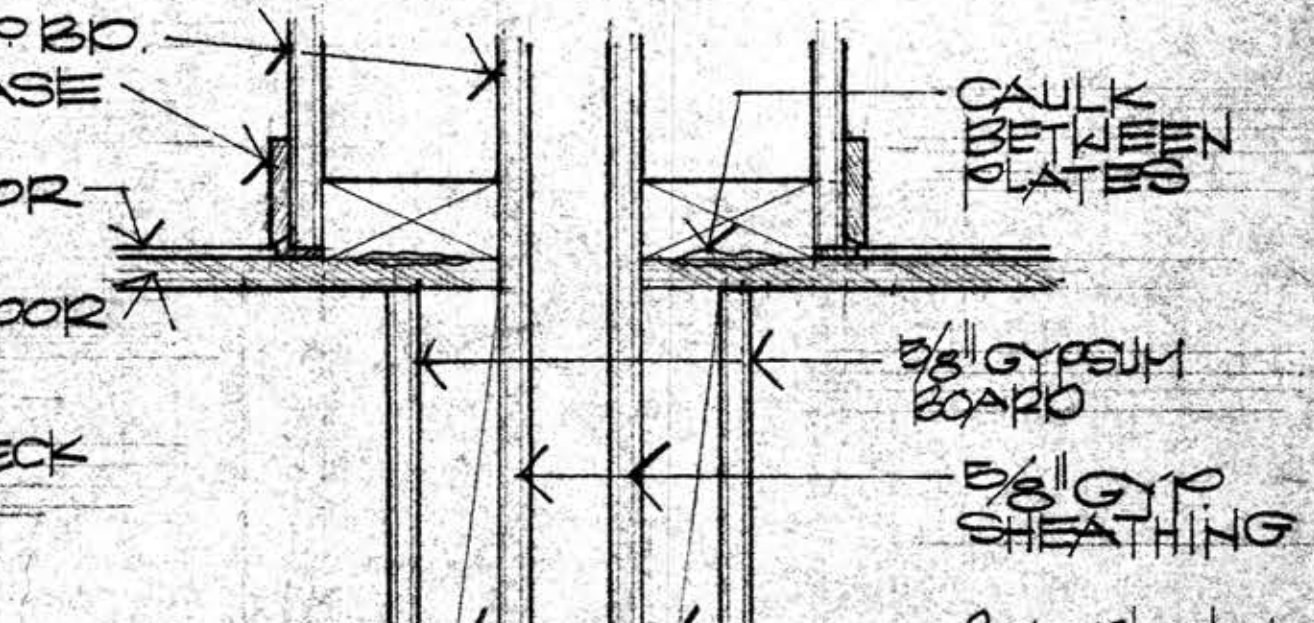

2 PARTY WALL DETAIL

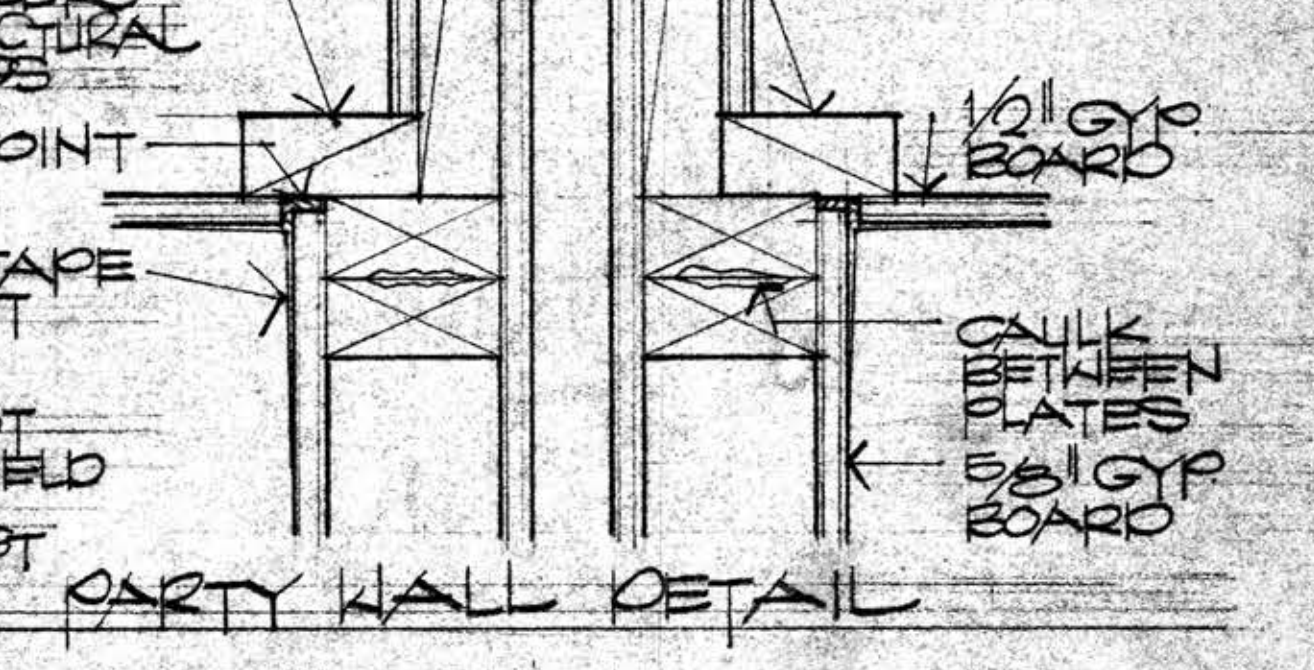

3 PARTY WALL DETAIL

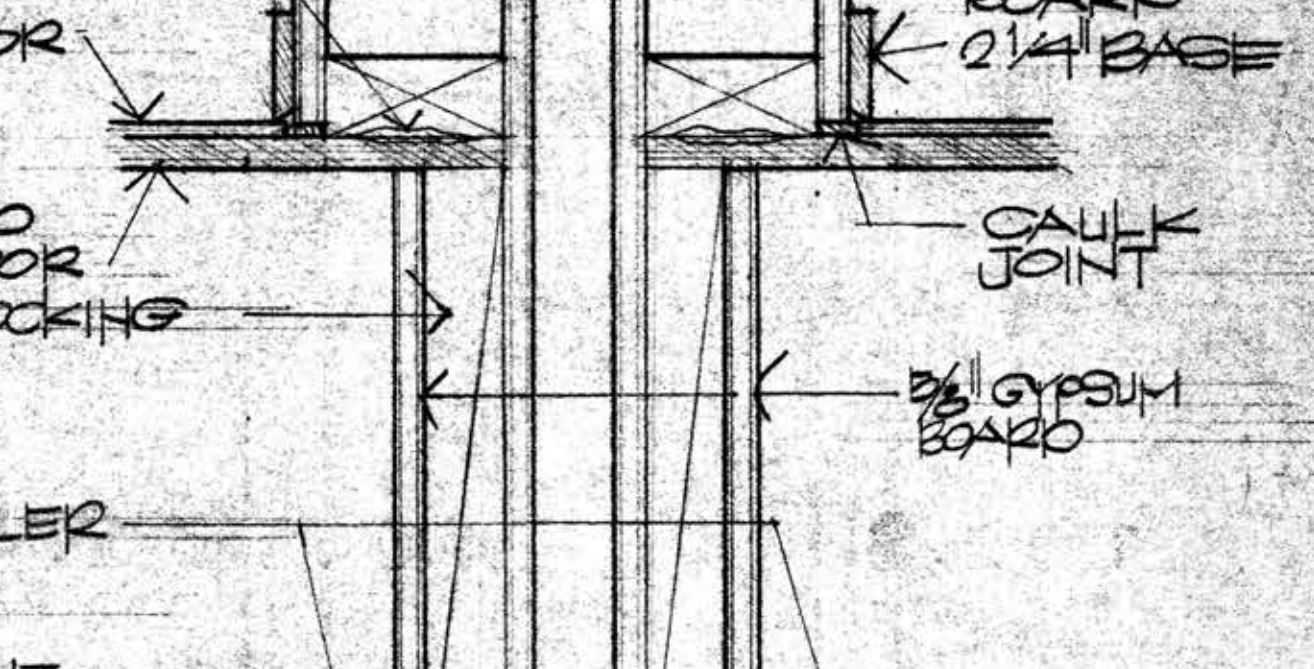

4 PARTY WALL DETAIL

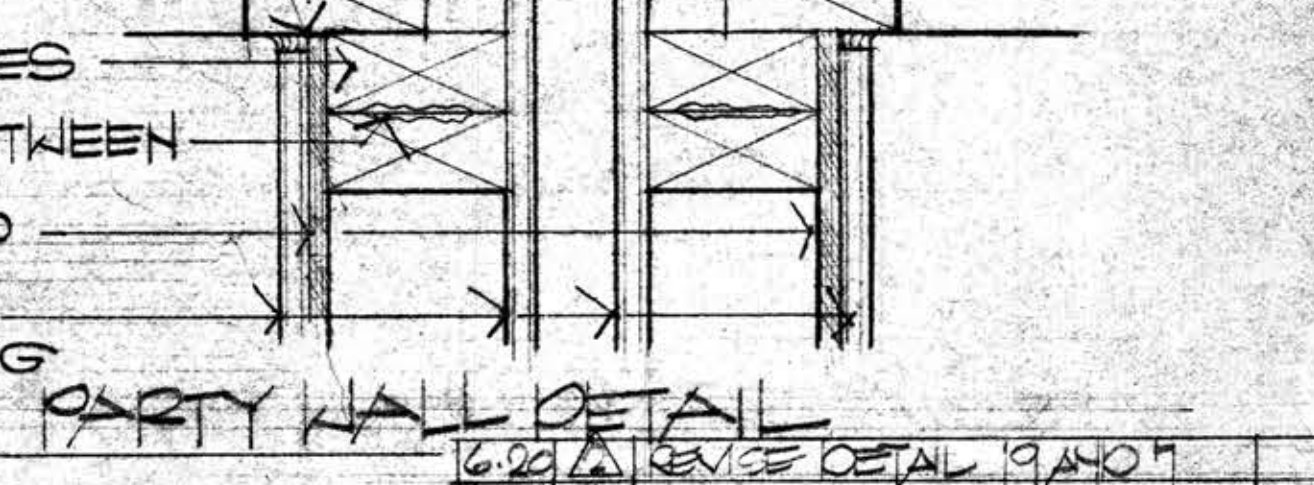

5 PARTY WALL DETAIL

DATE	NO.	REVISION	BY
1-11	1	6.02 REVISION DETAIL 9/4/07	

JOB NO.
6802
DATE
11.11.00

BALLENA BAY TOWNHOUSES
ALAMEDA CALIFORNIA

DETAILS

SHEET
10